



KQLE

智慧变频泵

高效泵+数字变频控制器+智能监控=全新高效系统解决方案

供暖和制冷系统完美解决方案的八大优点



更智慧

--24小时全天候实时监控水泵的运行状态、进口压力、出口压力、运行的频率、耗能指标、故障预警



更可靠

--数字集成设计，接线少，故障点少。
--变频器的PCBA加厚工业涂层，防尘、防潮、防盐雾



更高效

--全变频，减少能耗
--全自动，用户省心



五年质保

--上海凯泉承诺五年质保



使用更简便

--泵房设备“零”布线，省时省工；
--参数自适应，“一键设定”，调试快速便捷；
--整机更换简便



IP55防护等级

--设备IP55防护等级，防尘、防水



e数字能耗管理

--实时压力、流量、电流、能耗彩屏显示（支持波形）



功能更强大

--全变频+高性能数字PID，供水舒适好
--可靠预警、报警、智能控制
--压力+电功率、能效等大数据检测及云平台远程监控（五年免费）
--支持多台泵联控运行，均衡每台泵运行时间

产品简介

- KQLE智慧变频泵依托于我公司第六代单级单吸离心泵，其高效、节能、可靠的性能及品质达到国外名牌产品水平。
- KQLE智慧变频泵是集供暖，制冷和管道系统为一体的智慧产品，采用了电机、水泵、智能变频控制器、故障预警等设计方案，在满足泵送功能的同时，带给您更高价值的体验。
- 7.5kW以下产品无故障预警功能

结构图

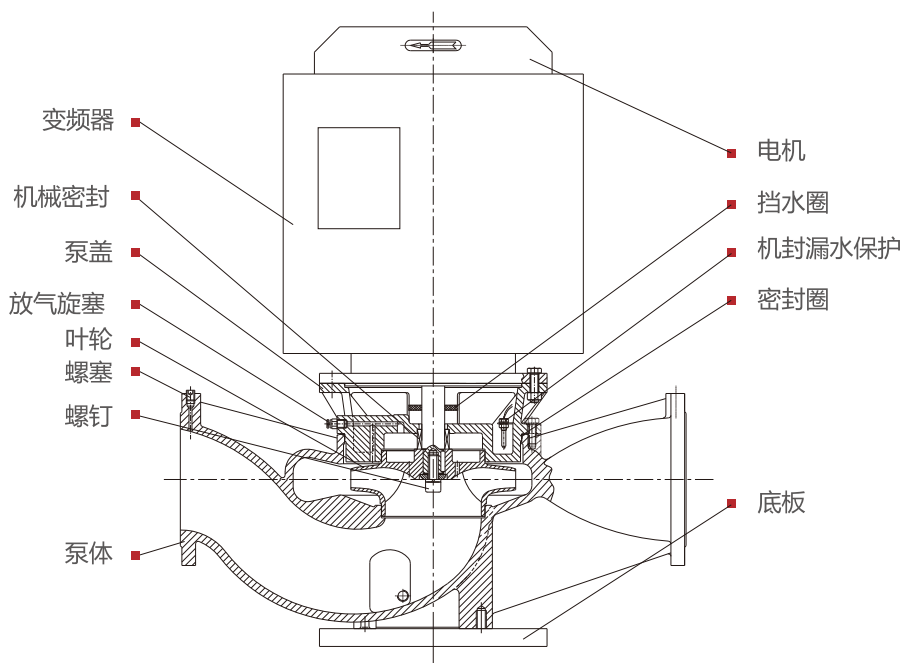

优化升级

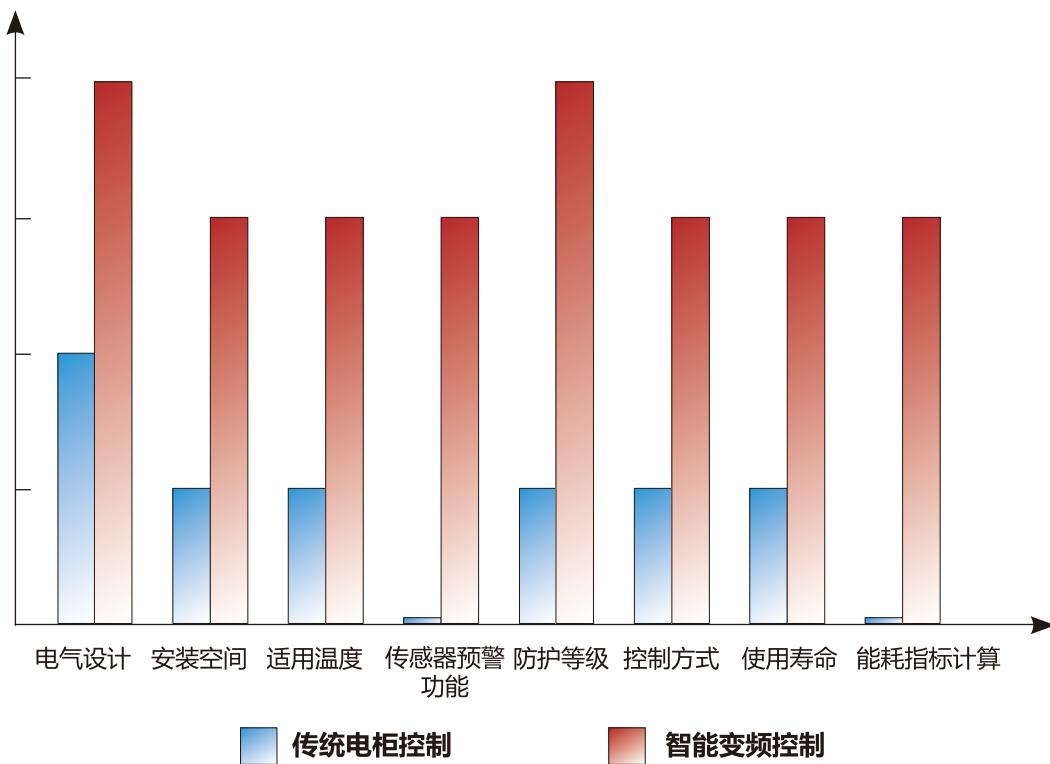

型谱图

功率范围2.2kW~75kW

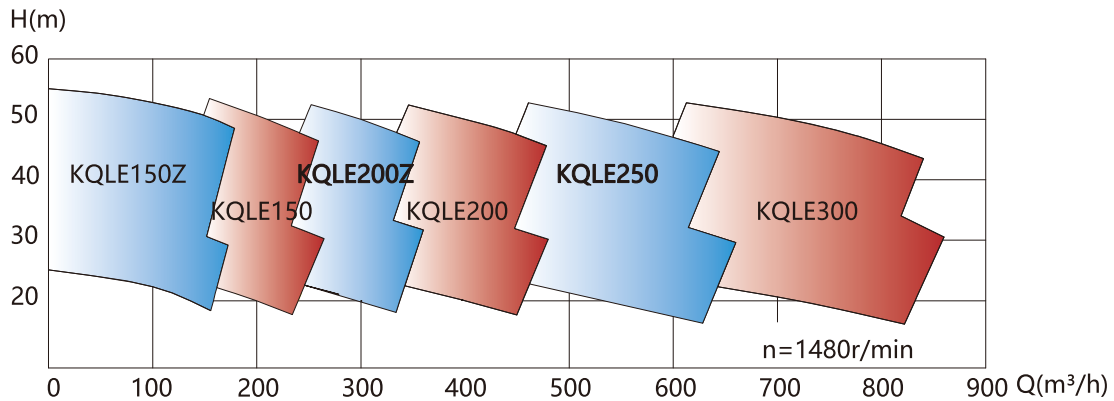
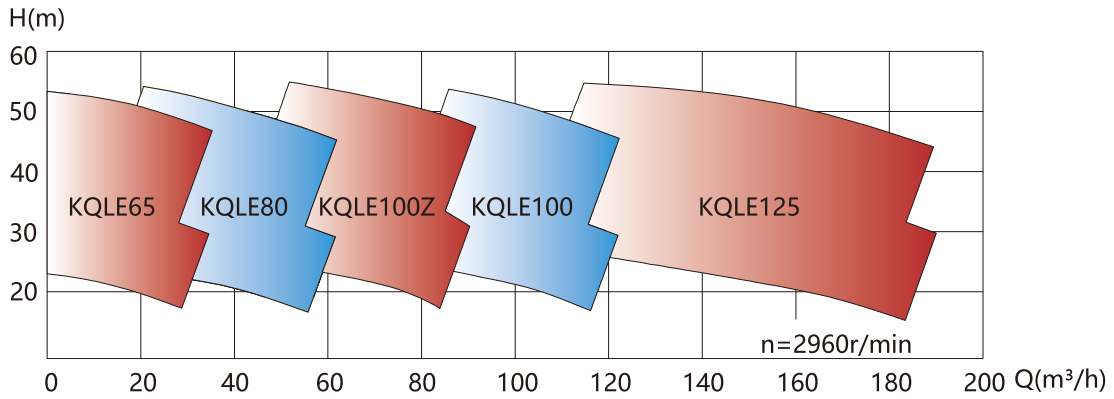

智慧物联

- **KQLE智慧变频泵**配置智能变频无传感器功能后，泵控制器内存中将保存水泵的性能特性曲线。运行时，无传感器控制器负责监测功率和水泵转速，建立系统的流量要求，并对水泵进行控制，从而确保运行点沿着控制曲线移动。运行过程中，根据实际的系统特性，控制器自动调节泵速，来满足系统需求，同时确保泵在控制曲线上以最低速度运转，使生命周期成本降至最低。

- **人性化中文界面，彩屏UI设计。**

- **互联性，标配内置物联网远传模块，可选配wifi模块，让用户远端轻松查看实时运行状态。**



追踪数据

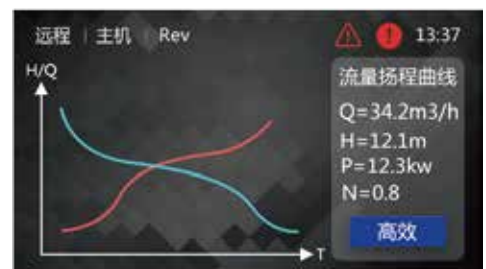
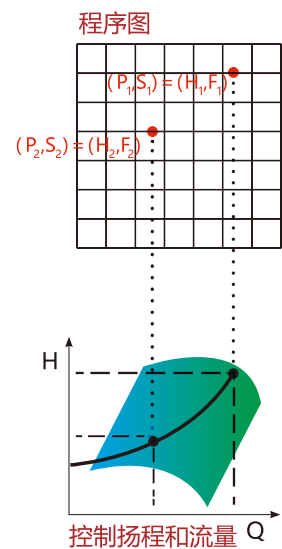

性能参数表 (50Hz)

型 号	流量		扬程 (m)	转速 (r/min)	效率 (%)	电机 功率 (kW)	必需汽蚀余量 (NPSH) _r
	(m ³ /h)	(l/s)					
65/125S-2.2/2	17.5	4.9	21	2960	71.4	2.2	2.5
	25	6.9	20				
	27.5	7.6	18				
65/140S-2.2/2	14	3.9	25.2	2960	65	2.2	2.5
	20	6.0	24				
	22	6.1	21.6				
65/150S-3/2	16.1	4.5	29.4	2960	66	3	2.5
	23	6.5	28				
	25.3	7.0	25.2				
65/160-4/2	17.5	4.9	34.3	2960	66.7	4	2.5
	25	6.9	32				
	30	8.3	27.5				
65/170S-5.5/2	15.2	4.2	40	2960	57	5.5	2.5
	21.8	6.1	38				
	26.2	7.2	34.5				
65/185S-5.5/2	16.4	4.6	46.2	2960	58	5.5	2.5
	23.4	6.5	44				
	25.7	7.2	39.6				
65/200S-7.5/2	17.5	4.9	52.7	2960	59	7.5	2.5
	25	6.9	50				
	30	8.3	45.5				
80/125S-4/2	35	9.7	21	2960	76.9	4	3
	50	13.9	20				
	55	15.3	18				
80/140S-4/2	28	7.8	25.2	2960	75	4	3
	40	12	24				
	44	12.2	21.6				
80/150S-5.5/2	32.7	9.1	29.4	2960	75	5.5	3
	46.7	13	28				
	51.4	14.3	25.2				
80/160-7.5/2	35	9.7	35	2960	75.4	7.5	3
	50	13.9	32				
	60	16.7	28				
80/165-5.5/2	24.5	6.8	35.7	2960	70	5.5	3
	35	9.7	34				
	38.5	10.7	30.6				
80/170S-7.5/2	30.5	8.5	40.6	2960	70	7.5	3
	43.5	12.1	38				
	52	14.4	33.4				
80/185S-11/2	32.8	9.1	47	2960	70	11	3
	47	13.1	44				
	56.4	15.7	40				

性能参数表 (50Hz)

型 号	流量		扬程 (m)	转速 (r/min)	效率 (%)	电机 功率 (kW)	必需汽蚀余量 (NPSH)r
	(m³/h)	(l/s)					
80/200-15/2	35	9.7	53.5	2960	71.4	15	3
	50	13.9	50				
	60	16.7	46				
100/125-5.5/2(Z)	49	13.6	21	2960	78	5.5	4.5
	70	19.4	20				
	77	21.4	18				
100/150-7.5/2(Z)	49	13.6	27.3	2960	77	7.5	4.5
	70	19.4	26				
	77	21.4	23.4				
100/160-11/2(Z)	52.5	14.6	33.6	2960	78	11	4.5
	75	20.8	32				
	82.5	22.9	28.8				
100/170-11/2(Z)	47.6	13.2	39.9	2960	74	11	4
	68	18.9	38				
	74.8	20.8	34.2				
100/185-15/2(Z)	50.4	14	46.2	2960	75	15	4
	72	20	44				
	79.2	22	39.6				
100/200-18.5/2(Z)	52.5	14.6	52.5	2960	76	18.5	4
	75	20.8	50				
	82.5	22.9	45				
100/125S-7.5/2	66.5	18.5	21	2960	80	7.5	4.5
	95	26.4	20				
	104.5	29	18				
100/140S-7.5/2	56	15.6	25.2	2960	79	7.5	4.5
	80	22.2	24				
	88	24.4	21.6				
100/150-11/2	65.4	18.2	32	2960	78	11	4.5
	93.5	26	28				
	112	31.1	21				
100/160-15/2	70	19.4	36.5	2960	79	15	4.5
	100	27.8	32				
	120	33.3	24				
100/165-15/2	80.5	22.4	38.5	2960	79	15	4.5
	115	31.9	34				
	126.5	35.1	32				
100/185S-18.5/2	65.4	18.2	47.5	2960	78	18.5	4
	93.5	26	44				
	112	31.1	37				
100/200S-22/2	70	19.4	54	2960	79	22	4
	100	27.8	50				
	120	33.3	42				

性能参数表 (50Hz)

型 号	流量		扬程 (m)	转速 (r/min)	效率 (%)	电机 功率 (kW)	必需汽蚀余量 (NPSH) _r
	(m ³ /h)	(l/s)					
125/125-15/2	96	26.7	22.6	2960	81	15	4
	160	44.4	20				
	192	53.3	17				
125/140-15/2	83	21.7	27.5	2960	80	15	4
	138	38.3	24				
	166	46.1	21				
125/150-18.5/2	90	25	31.5	2960	81	18.5	4
	150	41.7	28				
	180	50	24.5				
125/160-22/2	96	26.7	36	2960	82	22	4
	160	44.4	32				
	192	53.3	28				
125/170-22/2	83	21.7	41.3	2960	80	22	5.5
	138	38.3	37.5				
	166	46.1	34.5				
125/185-30/2	90	25	48.4	2960	81	30	5.5
	150	41.7	44				
	180	50	40.5				
125/200-37/2	96	26.7	55	2960	82	37	5.5
	160	44.4	50				
	192	53.3	46				
150/250-11/4(Z)	98	27.2	21	1480	79	11	3
	140	38.9	20				
	154	42.8	18				
150/285-15/4(Z)	112	31.1	25.2	1480	76	15	3
	160	44.4	24				
	176	48.9	21.6				
150/300-18.5/4(Z)	105	29.2	29.4	1480	78	18.5	3
	150	41.7	28				
	165	45.8	25.2				
150/315-22/4(Z)	112	31.1	33.6	1480	79	22	3
	160	44.4	32				
	176	48.9	28.8				
150/345-22/4(Z)	96.6	26.8	39.9	1480	72	22	3.5
	138	38.3	38				
	151.8	42.2	34.2				
150/370-30/4(Z)	105	29.2	46.2	1480	73	30	3.5
	150	41.7	44				
	165	45.8	39.6				
150/400-37/4(Z)	112	31.1	33.8	1480	74.7	37	3.5
	160	44.4	50				
	176	48.9	28				

性能参数表 (50Hz)

型 号	流量		扬程 (m)	转速 (r/min)	效率 (%)	电机 功率 (kW)	必需汽蚀余量 (NPSH)r
	(m ³ /h)	(l/s)					
150/250S-15/4	140	38.9	21.8	1480	82.8	15	3
	200	55.6	20				
	220	61.1	18				
150/285-18.5/4	121	33.6	25.8	1480	79	18.5	3.5
	173	48.1	24				
	208	57.8	20.7				
150/290-22/4	140	38.9	29.4	1480	81.7	22	3.5
	200	55.6	28				
	220	61.1	24.5				
150/315-30/4	140	38.9	33.8	1480	81.7	30	3.5
	200	55.6	32				
	240	66.7	28				
150/350-30/4	140	38.9	39.9	1480	77	30	3.5
	200	55.6	38				
	210	58.3	34.2				
150/370-37/4	131	36.4	46.6	1480	76	37	3.5
	187	51.9	44				
	225	62.5	38.3				
150/400-45/4	140	38.9	53	1480	77	45	3.5
	200	55.6	50				
	240	66.7	44				
200/250S-22/4(Z)	210	58.3	21	1480	84	22	4
	300	83.3	20				
	330	91.7	18				
200/285S-22/4(Z)	171	47.5	25.2	1480	82	22	4
	245	72.2	24				
	270	75	16				
200/300S-30/4(Z)	196	54.4	29.4	1480	83.8	30	4
	280	77.9	28				
	308	85.7	25.2				
200/315S-37/4(Z)	210	58.3	33.6	1480	83.8	37	4
	300	83.3	32				
	330	91.7	28.8				
200/345-45/4(Z)	182	50.6	41.4	1480	78	45	4
	262	72.2	38				
	312	86.7	29.6				
200/370S-45/4(Z)	189	52.5	46.2	1480	80	45	4
	270	75	44				
	297	82.5	39.6				
200/400S-55/4(Z)	210	58.3	50.4	1480	81.6	55	4
	300	83.3	48				
	330	91.7	43.2				

性能参数表 (50Hz)

型 号	流量		扬程 (m)	转速 (r/min)	效率 (%)	电机 功率 (kW)	必需汽蚀余量 (NPSH) _r
	(m ³ /h)	(l/s)					
200/250-30/4	280	77.8	22.2	1480	84	30	4
	400	111.1	20				
	480	133.3	14				
200/285S-30/4	238	66.1	25.2	1480	80	30	4
	340	96.1	24				
	370	102.8	21.6				
200/300S-37/4	252	70	31.5	1480	81	37	4
	360	100	28				
	396	110	23				
200/315S-45/4	273	75.8	33.6	1480	83.9	45	4
	390	108.3	32				
	429	119.2	28.8				
200/345S-45/4	238	66.1	37.8	1480	80	45	4
	340	96.1	36				
	374	103.9	32.4				
200/350-55/4	259	71.9	42	1480	82	55	4
	370	96.1	40				
	407	113.1	36				
200/370-75/4	262	72.8	48	1480	81	75	4
	374	103.9	44				
	449	124.7	34				
200/400-75/4	280	77.8	54.5	1480	82.6	75	4
	400	111.1	50				
	480	133.3	39				
250/250S-37/4	364	101.1	21	1480	84.5	37	5.5
	520	144.4	20				
	572	158.9	18				
250/290-45/4	350	97.2	26.2	1480	84.7	45	5.5
	500	138.9	25				
	550	152.8	22.5				
250/300-55/4	365	101.4	31.5	1480	83	55	5.5
	500	138.9	28				
	600	166.7	23				
250/315-75/4	400	111.1	34.5	1480	85	75	5.5
	550	152.8	32				
	660	183.3	26				
250/350-75/4	350	97.2	43.1	1480	83	75	5.5
	500	138.9	41				
	550	152.8	36.9				

性能曲线图

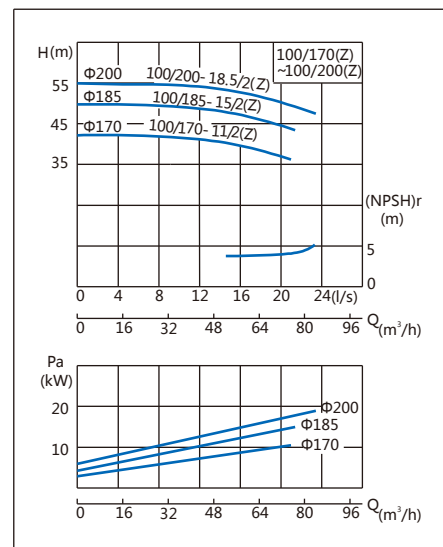
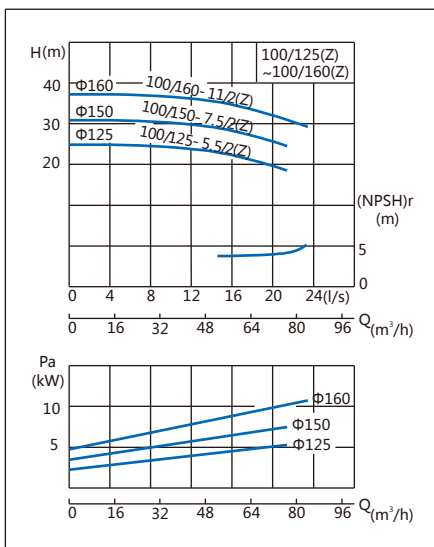
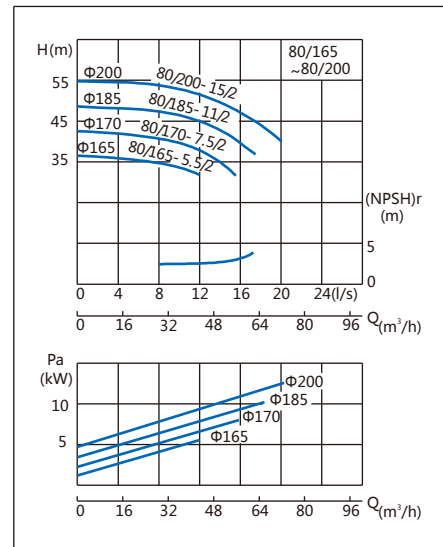
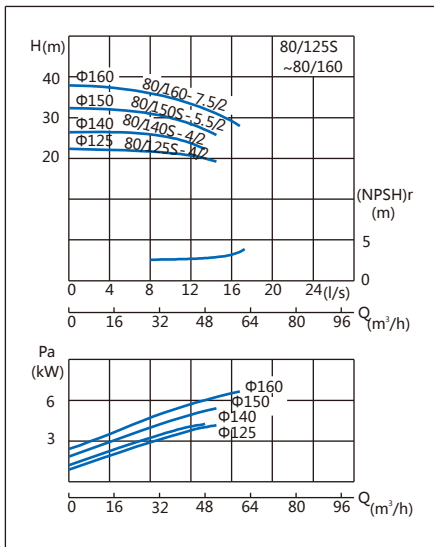
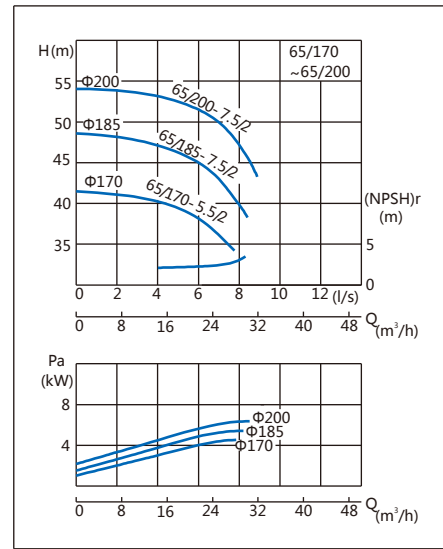
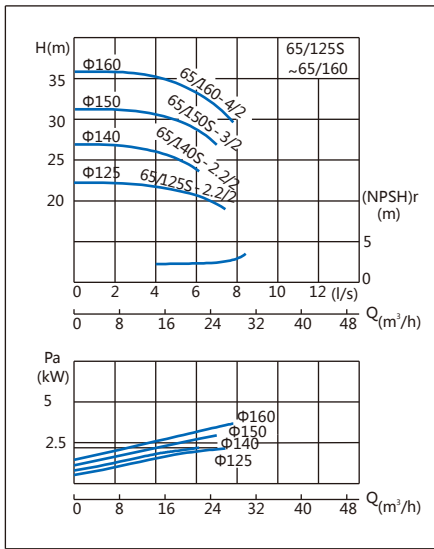

性能曲线图

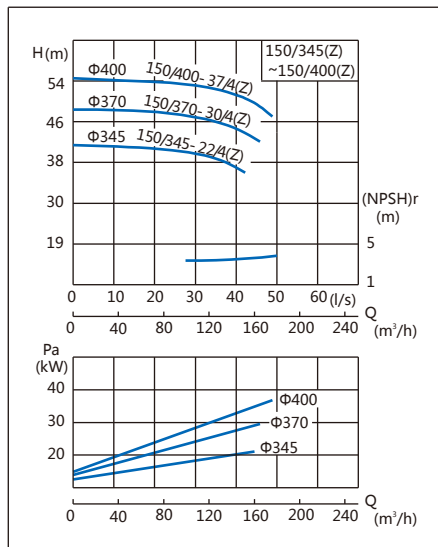
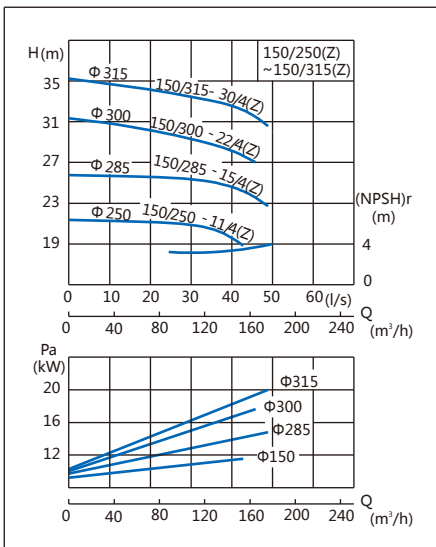
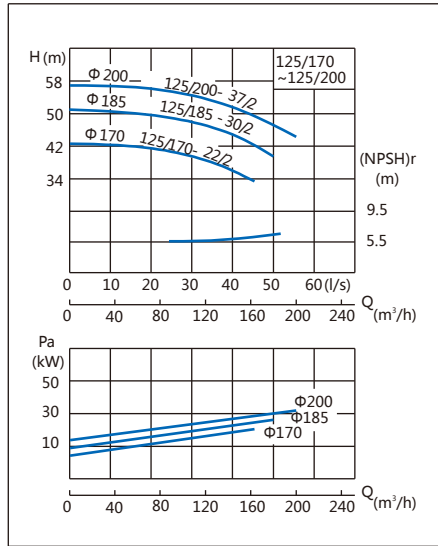
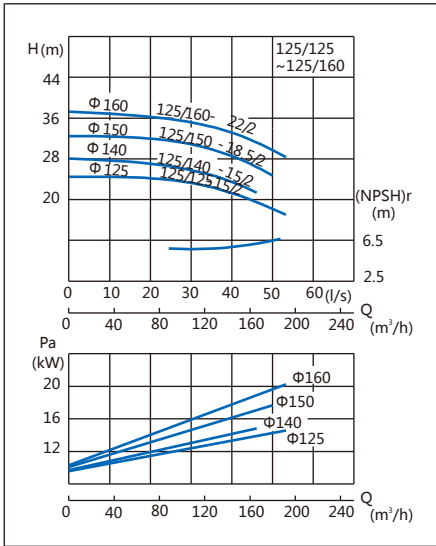
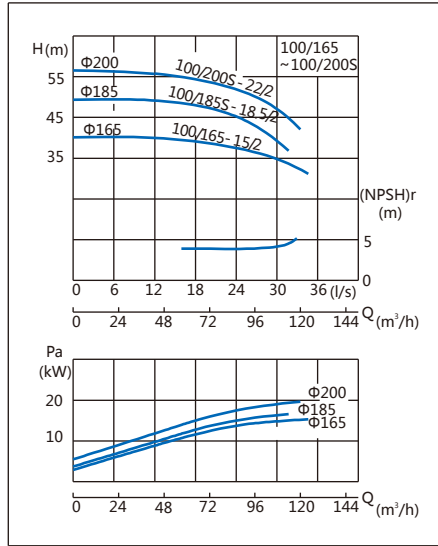
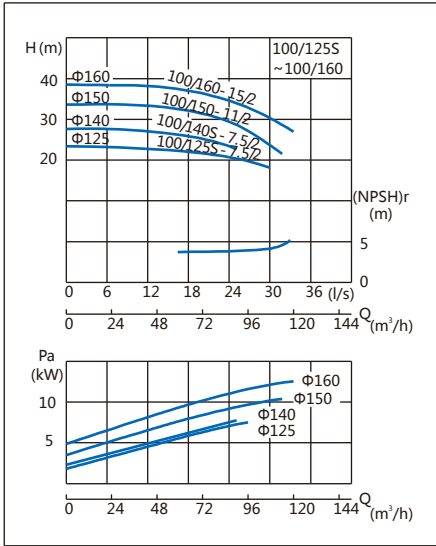

性能曲线图

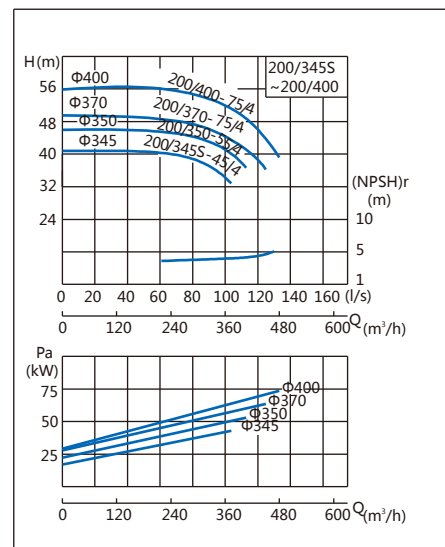
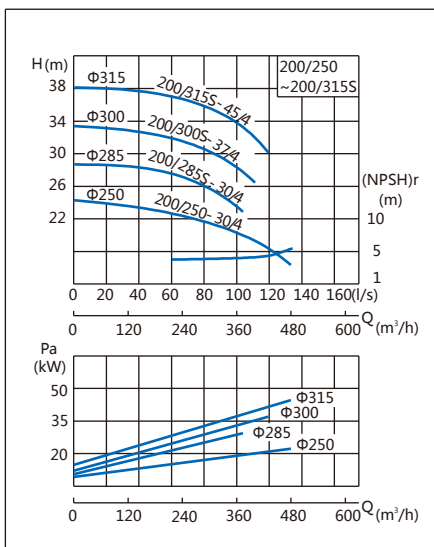
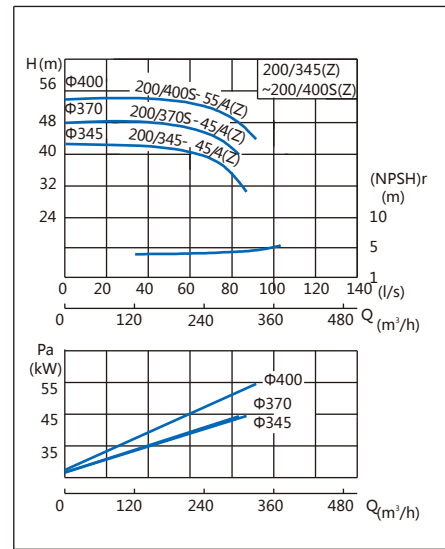
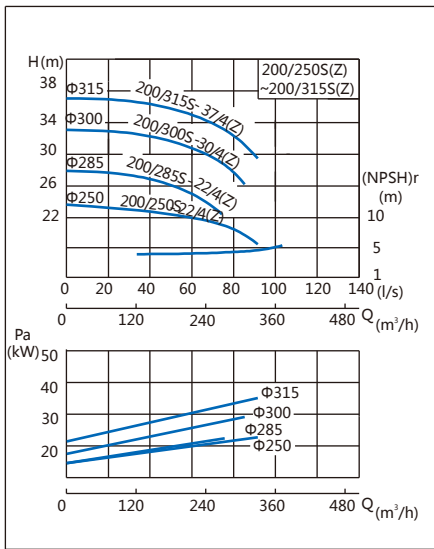
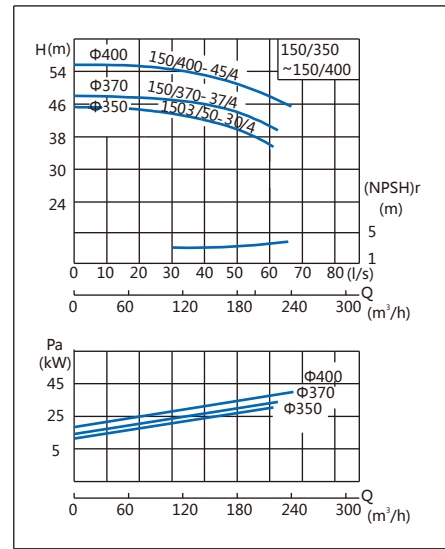
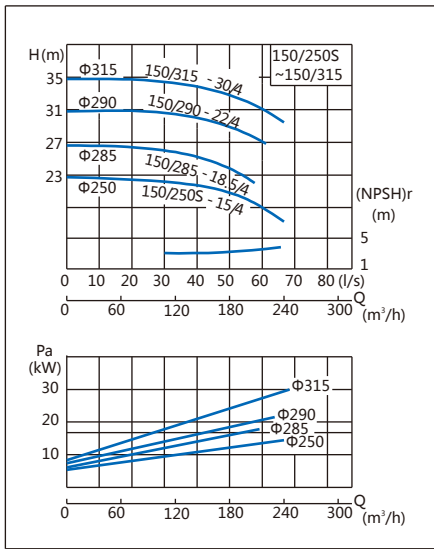

性能曲线图

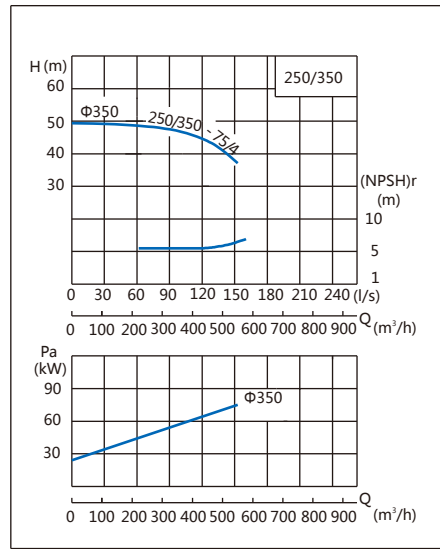
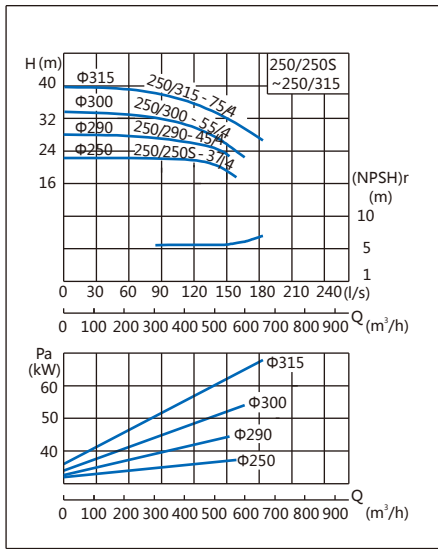

外形尺寸图

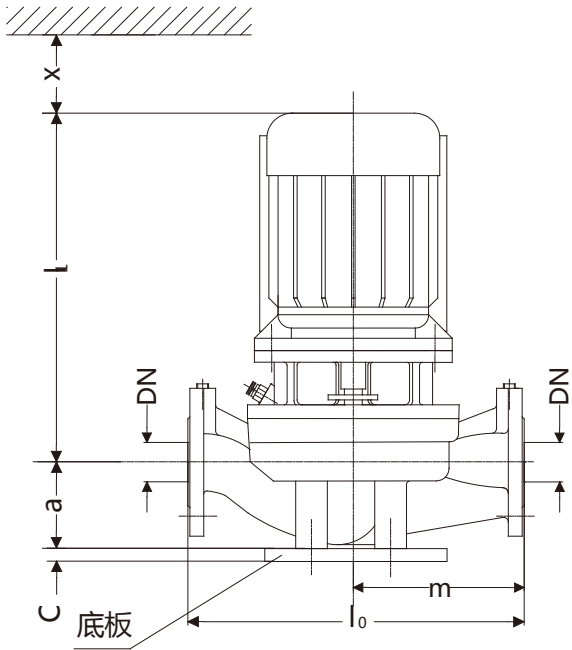

法兰PN16-GB/T17241.6				
DN	D	k	d	n×dL
	mm			数量×mm
65	185	145	118	4×Φ18
80	200	160	132	8×Φ18
100	220	180	156	8×Φ18
125	250	210	184	8×Φ18
150	285	240	211	8×Φ22
200	340	295	266	12×Φ22
250	405	355	319	12×Φ26

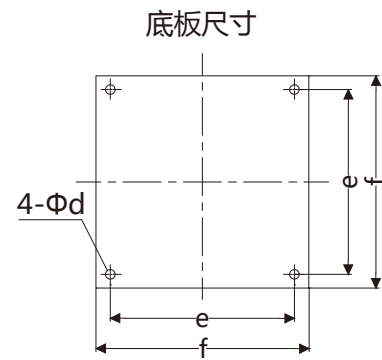
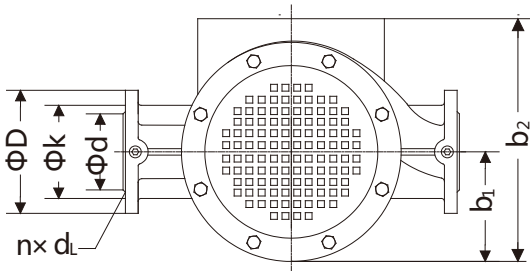

安装尺寸图表

型号	DN	l ₀	m	a	c	l ₁	b ₁	b ₂	x	f	e	d	隔振器 (垫)	底板代号
	mm													
65/125S-2.2/2	65	420	210	130	30	470	120	400	105	250	210	14	SD1-61-0.5	KQN-2
65/140S-2.2/2	65	420	210	130	30	470	120	400	105	250	210	14	SD1-61-0.5	KQN-2
65/150S-3/2	65	420	210	130	30	505	125	405	105	250	210	14	SD1-61-0.5	KQN-2
65/160-4/2	65	420	210	130	30	540	125	425	105	250	210	14	SD1-61-0.5	KQN-2
65/170S-5.5/2	65	400	200	150	30	577	185	485	105	250	210	14	SD1-61-0.5	KQN-2
65/185S-5.5/2	65	400	200	150	30	577	185	485	105	250	210	14	SD1-61-0.5	KQN-2
65/200S-7.5/2	65	400	200	150	30	577	185	485	105	250	210	14	SD1-61-0.5	KQN-2
80/125S-4/2	80	490	245	145	30	540	150	450	110	250	210	14	SD1-61-0.5	KQN-2
80/140S-4/2	80	490	245	145	30	540	150	450	110	250	210	14	SD1-61-0.5	KQN-2
80/150S-5.5/2	80	490	245	145	30	560	150	480	110	250	210	14	SD1-61-0.5	KQN-2
80/160-7.5/2	80	490	245	145	30	560	150	480	110	250	210	14	SD1-61-0.5	KQN-2
80/165-5.5/2	80	490	245	145	30	560	150	480	110	250	210	14	SD1-61-0.5	KQN-2
80/170S-7.5/2	80	500	250	155	30	575	185	505	120	250	210	14	JG2-2	KQN-2
80/185S-11/2	80	500	250	155	30	705	225	565	120	250	210	14	JG2-2	KQN-2
80/200-15/2	80	540	270	155	30	705	175	565	120	250	210	14	JG2-2	KQN-2
100/125-5.5/2(Z)	100	580	280	180	30	580	155	485	130	330	290	18	JG3-1	KQN-3
100/150-7.5/2(Z)	100	580	280	180	30	580	155	485	130	330	290	18	JG3-1	KQN-3
100/160-11/2(Z)	100	580	280	180	30	710	175	565	130	330	290	18	JG3-1	KQN-3
100/170-11/2(Z)	100	580	280	180	30	720	225	580	130	330	290	18	JG3-1	KQN-3
100/185-15/2(Z)	100	580	280	180	30	720	225	580	130	330	290	18	JG3-1	KQN-3
100/200-18.5/2(Z)	100	580	280	180	30	750	225	587	130	330	290	18	JG3-1	KQN-3
100/125S-7.5/2	100	580	280	180	30	580	155	485	130	330	290	18	JG3-1	KQN-3
100/140S-7.5/2	100	580	280	180	30	580	155	485	130	330	290	18	JG3-1	KQN-3
100/150-11/2	100	580	280	180	30	710	175	565	130	330	290	18	JG3-1	KQN-3
100/160-15/2	100	580	280	180	30	710	175	565	130	330	290	18	JG3-1	KQN-3
100/165-15/2	100	580	280	180	30	710	175	565	130	330	290	18	JG3-1	KQN-3
100/185S-18.5/2	100	580	280	180	30	750	225	587	130	330	290	18	JG3-1	KQN-3
100/200S-22/2	100	580	280	180	30	790	225	607	130	330	290	18	JG3-1	KQN-3
125/125-15/2	125	645	320	220	30	715	190	580	130	330	290	18	JG3-1	KQN-3
125/140-15/2	125	645	320	220	30	715	190	580	130	330	290	18	JG3-1	KQN-3
125/150-18.5/2	125	645	320	220	30	747	190	587	130	330	290	18	JG3-1	KQN-3
125/160-22/2	125	645	320	220	30	789	190	607	130	330	290	18	JG3-1	KQN-3
125/170-22/2	125	645	320	220	30	789	190	607	130	330	290	18	JG3-1	KQN-3
125/185-30/2	125	570	285	172	30	860	210	647	140	330	290	18	JG3-2	KQN-3
125/200-37/2	125	570	285	172	30	860	210	729	140	330	290	18	JG3-2	KQN-3
150/250-11/4(Z)	150	880	430	265	37	725	235	485	150	400	360	18	JG3-1	KQN-4
150/285-15/4(Z)	150	880	430	274	37	758	250	640	155	400	360	18	JG3-2	KQN-4
150/300-18.5/4(Z)	150	880	430	274	37	795	250	667	155	400	360	18	JG3-2	KQN-4
150/315-22/4(Z)	150	880	430	274	37	845	250	667	155	400	360	18	JG3-2	KQN-4
150/345-22/4(Z)	150	880	430	274	37	845	250	667	155	400	360	18	JG3-2	KQN-4
150/370-30/4(Z)	150	970	480	280	37	845	285	722	155	400	360	18	JG3-2	KQN-4
150/400-37/4(Z)	150	970	480	280	37	859	285	829	155	400	360	18	JG3-2	KQN-4
150/250S-15/4	150	880	430	265	37	757	235	625	150	400	360	18	JG3-2	KQN-5
150/285-18.5/4	150	880	430	274	37	795	250	667	155	400	360	18	JG3-2	KQN-4
150/290-22/4	150	880	430	274	37	845	250	667	155	400	360	18	JG3-2	KQN-4
150/315-30/4	150	880	430	274	37	845	250	687	155	400	360	18	JG3-2	KQN-4
150/350-30/4	150	880	430	274	37	845	250	687	155	400	360	18	JG3-2	KQN-4
150/370-37/4	150	970	480	280	37	859	285	829	155	400	360	18	JG3-2	KQN-4
150/400-45/4	150	970	480	280	37	887	285	829	155	400	360	18	JG3-2	KQN-4

安装尺寸图表

型号	DN	l ₀	m	a	c	l ₁	b ₁	b ₂	x	f	e	d	隔振器(垫)	底板代号
	mm													
200/250S-22/4(Z)	200	990	480	275	37	873	285	702	150	450	400	22	JG3-2	KQN-5
200/285S-22/4(Z)	200	1000	500	295	37	876	320	737	155	450	400	22	JG3-2	KQN-5
200/300S-30/4(Z)	200	1000	500	295	37	876	320	757	155	450	400	22	JG3-2	KQN-5
200/315S-37/4(Z)	200	1000	500	295	37	886	320	864	155	450	400	22	JG3-2	KQN-5
200/345-45/4(Z)	200	1070	535	280	37	914	300	844	155	450	400	22	JG3-2	KQN-5
200/370S-45/4(Z)	200	1070	535	280	37	915	300	844	155	450	400	22	JG3-2	KQN-5
200/400S-55/4(Z)	200	1070	535	280	37	976	300	900	155	450	400	22	JG3-2	KQN-5
200/250-30/4	200	990	480	275	37	873	285	722	150	450	400	22	JG3-2	KQN-5
200/285S-30/4	200	1000	500	295	37	876	320	757	155	450	400	22	JG3-2	KQN-5
200/300S-37/4	200	1000	500	295	37	886	320	864	155	450	400	22	JG3-2	KQN-5
200/315S-45/4	200	1000	500	295	37	911	320	864	155	450	400	22	JG3-2	KQN-5
200/320-45/4	200	1070	535	280	37	914	300	844	155	450	400	22	JG3-2	KQN-5
200/345S-45/4	200	1070	535	280	37	914	300	844	155	450	400	22	JG3-2	KQN-5
200/350-55/4	200	1070	535	280	37	976	300	900	155	450	400	22	JG3-2	KQN-5
200/370-75/4	200	1070	535	280	37	1035	300	930	155	450	400	22	JG3-2	KQN-5
200/400-75/4	200	1070	535	280	37	1035	300	930	155	450	400	22	JG3-2	KQN-5
250/250S-37/4	250	1100	550	335	40	870	340	884	180	500	450	22	JG4-1	KQN-6
250/290-45/4	250	1100	550	335	40	915	340	884	180	500	450	22	JG4-1	KQN-6
250/300-55/4	250	1100	550	335	40	959	340	940	180	500	450	22	JG4-1	KQN-6
250/315-75/4	250	1100	550	335	40	1039	340	970	180	500	450	22	JG4-1	KQN-6
250/345-75/4	250	1200	600	335	40	1035	360	990	205	500	450	22	JG4-1	KQN-6
250/350-75/4	250	1200	600	335	40	1035	360	990	205	500	450	22	JG4-1	KQN-6

有 凯 泉 的 地 方 就 有 水



地址：上海市嘉定区曹安公路4255号/4287号
集团呼叫中心：400-002-6600
<http://www.kaiquan.com.cn>